



LONG "MARC" RUNNER FOR WOODEN DRAWER



A "MARC" Runner with pre-mounted self-closing device 20

Loading	Drawer length	Reference	Drawer slide RC	Carcase slide RF	Loss of extension PS	Drilling C
250 N. (25 kp.)	300	765.530.032	306	204	55	281
	350	765.535.035	356	236	55	331
	400	765.540.031	406	268	75	381
	450	765.545.034	456	300	75	431
	500	765.550.030	506	332	97	481

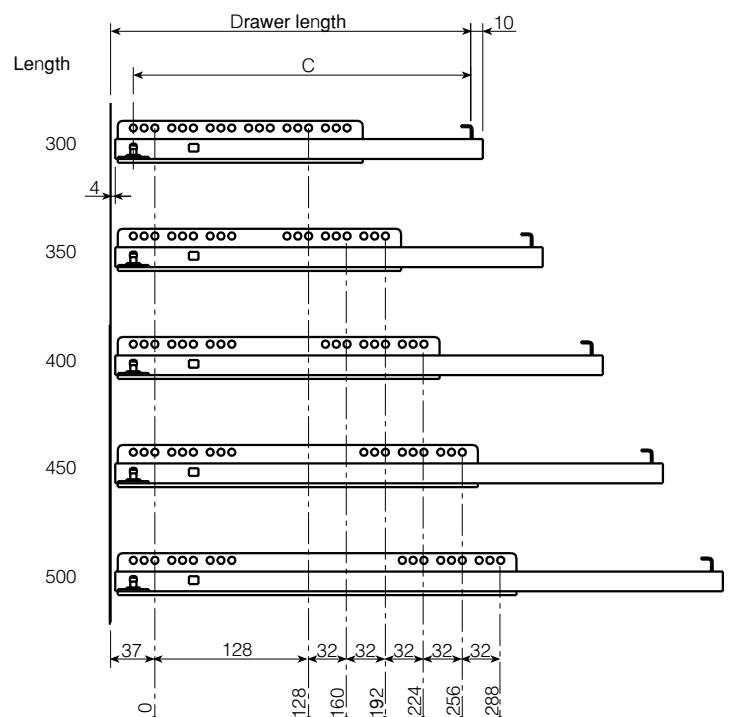
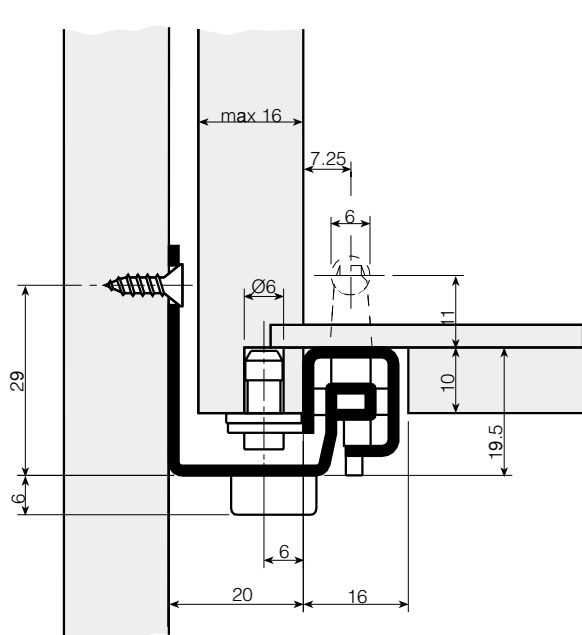



LONG "MARC" RUNNER QUICK-MOUNTING FOR WOODEN DRAWER



20

A "MARC" Runner with pre-mounted self-closing device

Loading	Drawer length	Reference	Drawer slide RC	Carcase slide RF	Loss of extension PS
250 N. (25 kp.)	300	765.730.033	306	204	55
	350	765.735.036	356	236	55
	400	765.740.032	406	268	75
	450	765.745.035	456	300	75
	500	765.750.031	506	332	97

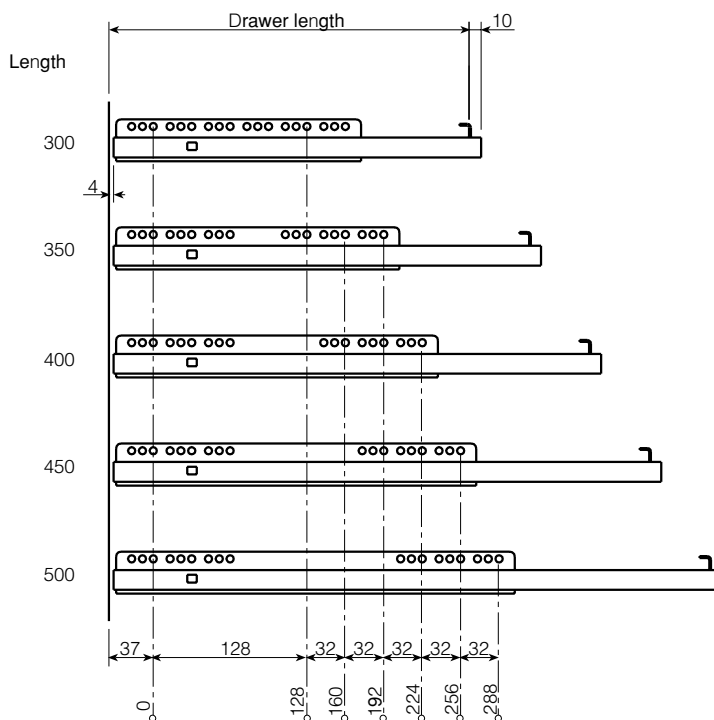
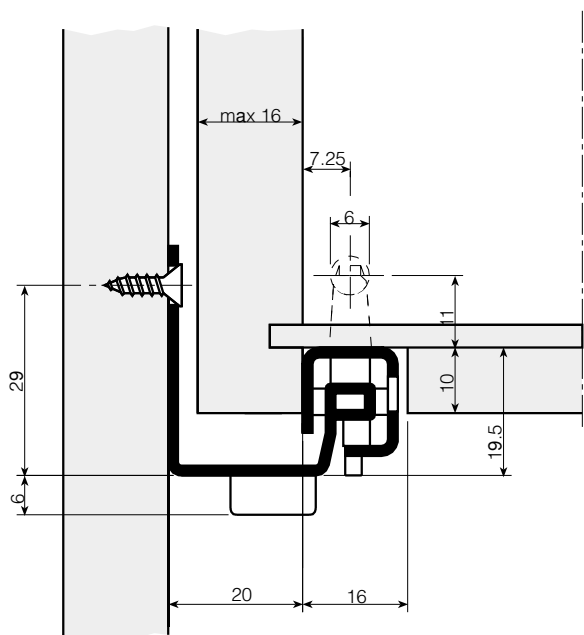

B Knock-in fixing system

731.202.102

100

Reference per set. Each set consists of 2 front fixing brackets.

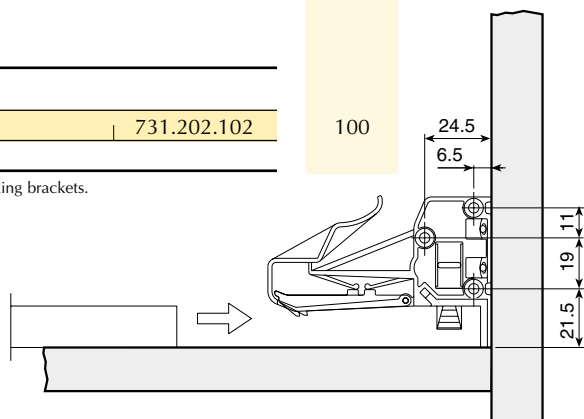



FULL EXTENSION "MARC" RUNNER QUICK-MOUNTING FOR WOODEN DRAWER



20

A "MARC" Full extension runner with pre-mounted self-closing device

Loading	Drawer length	Reference	Drawer slide RC	Carcase slide RF	Loss of extension PS
250 N. (25 kp.)	300	762.530.031	306	204	0
	350	762.535.034	356	236	0
	400	762.540.030	406	268	0
	450	762.545.033	456	300	0
	500	762.550.036	506	332	0

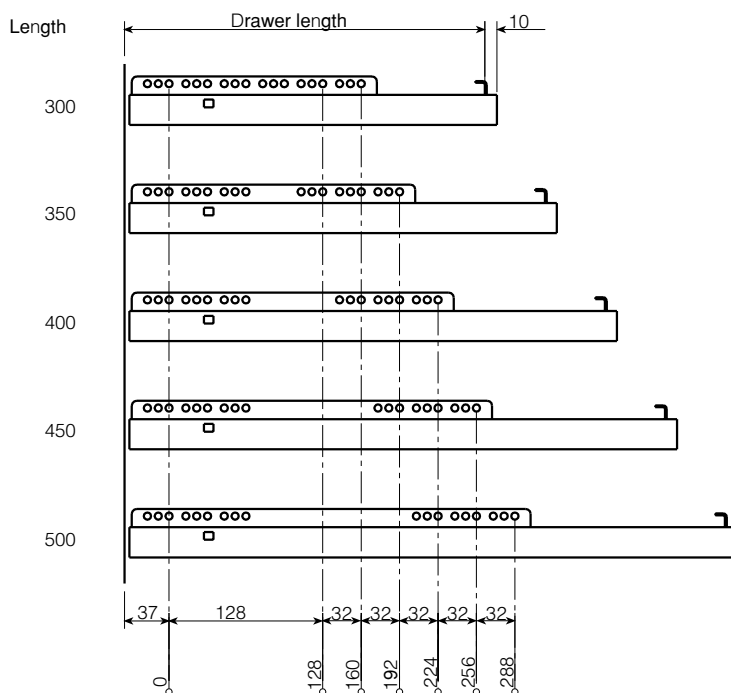
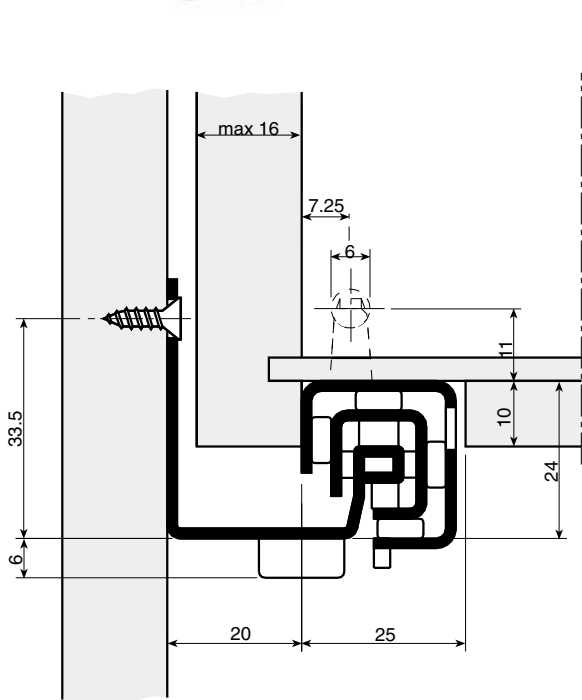

B Knock-in fixing system

731.202.102

100

Reference per set. Each set consists of 2 front fixing brackets.

