



"ALUX" DRAWER



A "ALUX" Drawer sides

Length	Silver anodized
270	679.127.514
400	679.140.512
480	679.148.514

This profile is supplied with screws.

20



B "ALUX" Drawer back for 16 mm drawer side

Module	Silver anodized
300	679.230.510
350	679.235.513
400	679.240.516
450	679.245.512
500	679.250.515
600	679.260.514

20



"ALUX-3"Drawer back. Special size cuts

Length	Silver anodized
To order	679.200.513

This profile is supplied cut to measure and is to be fixed to the drawer bottom and sides with connecting edges and screws.

20



"ALUX-3"Drawer back. Whole profile

Length	Silver anodized
2.770 mm	679.205.516

5

C Connecting edges

Grey RAL 7037	732.800.305
---------------	-------------

One right and one left edge per reference.

20



D Front adaptor for inner drawer

Grey RAL 7037	689.100.300
---------------	-------------

Reference consists of 1 complete set.

20



E Adjustable front fixing brackets

Screw-on mounting	689.200.105
Knock-in mounting Ø 8	688.300.104

One right and one left adaptor per reference.

100



F Cover

Grey RAL 7037	961.310.302
---------------	-------------

100





"ALUX" DRAWER TECHNICAL DATA

"ALUX-3".

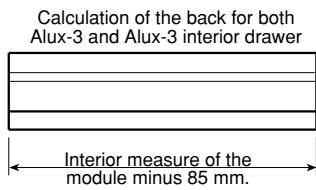
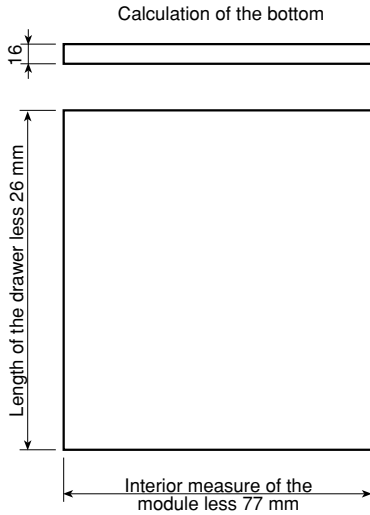

"ALUX-3" INTERIOR.

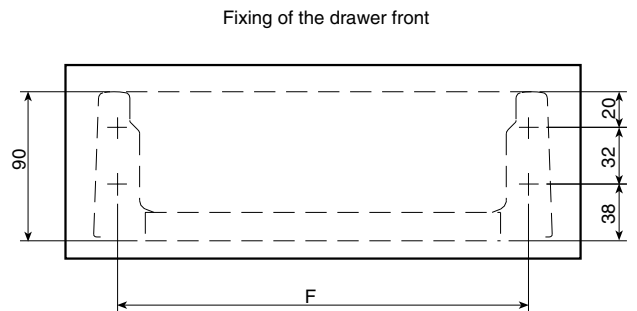
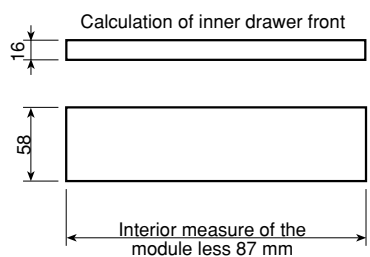
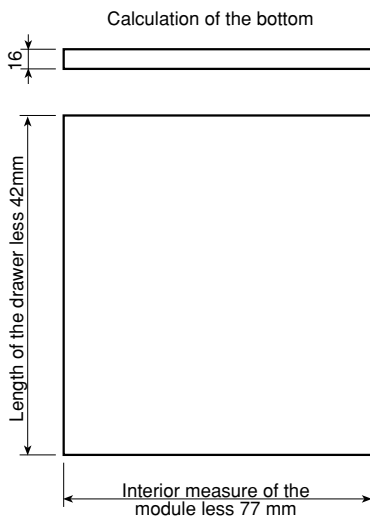

F=MI-45
MI=Interior measure of the module

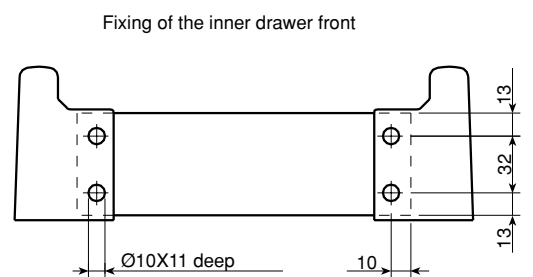



"ALUX" DRAWER RUNNERS



A "MARC" Runner with pre-mounted self-closing device

Length	Loss of extension PS	Reference
270	65	765.127.031
400	85	765.140.036
480	106	765.148.031

20



Length

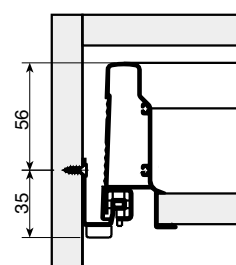
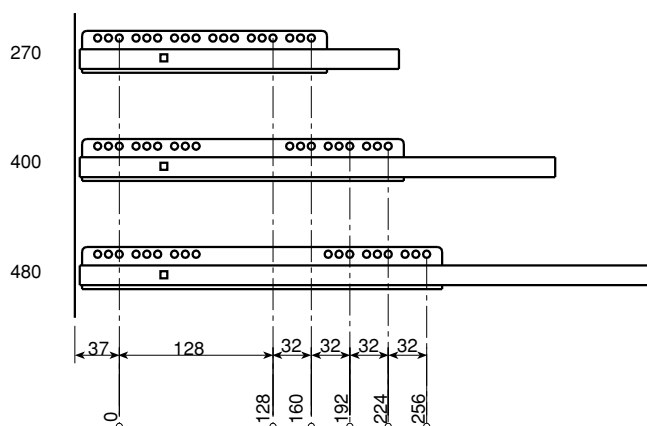

B "MARC" Full extension runner with self-closing system.

Length	Loss of extension PS	Reference
270	0	765.227.035
400	0	765.240.033
480	0	765.248.035

20



Length

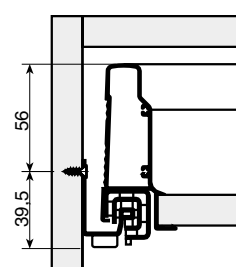
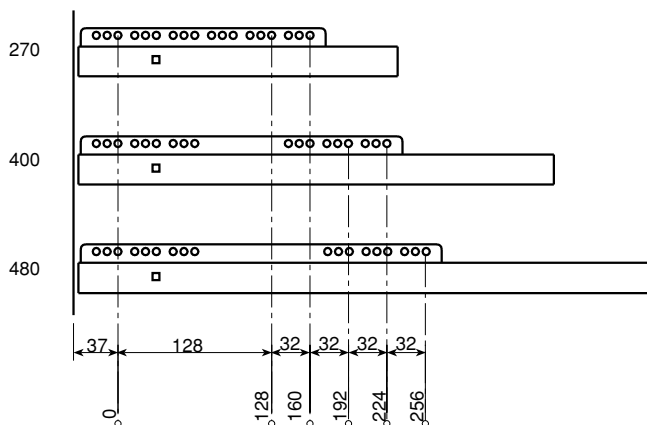



"ALUX" DRAWER PAN DRAWER EXTENDER AND ACCESSORIES



A Side rail

Drawer length	Silver anodized
270	746.227.506
400	746.240.504
480	746.248.506

50

B Cross rail for 16 mm drawer side

Module	Silver anodized
300	746.530.503
350	746.535.506
400	746.540.502
450	746.545.505
500	746.550.501
600	746.560.500

50

C Cross rail for special drawer size

To order	Silver anodized
	746.300.505

50

Bar length to be given in the order. MI= Interior measure of the furniture. L= MI-77.

D Bottle divider

Grey RAL 7037	748.100.301
---------------	-------------

50

E Corner joining bracket

Grey RAL 7037	732.900.302
---------------	-------------

20

Reference consists of 1 complete set.

F Cross rail fixing device

Grey RAL 7037	732.400.303
---------------	-------------

100

G Drawer front fixing

Grey RAL 7037	730.700.305
---------------	-------------

50

Reference consists of 1 complete set. 10 mm front adjustment.

H Cutlery Tray

Module	Grey RAL 7037
300	678.730.301
400	678.740.300
450	678.745.303
500	678.750.306
600	678.760.305

20

For 480 mm. long drawers.

